



Porta scorrevole a scomparsa su controtelaio senza stipite
Anta vetro satinato decorato mod "PUPA"
Nicchia a raso V-406 finitura cromo lucido

Frameless sliding pocket system
Satin glass door decorated "PUPA"
Sliding handle V-406 polished chrome finishes





**Doppia anta scorrevole, vetro satinato extrachiaro
Decoro dipinto a mano "Aras",
vetri fissi satinato extrachiaro
Sistema scorrevole invisibile V-7300
con due ante scorrevoli e due vetri fissi
Maniglie in vetro satinato M-009**

Sliding double doors
Satin finish low iron glass with red colored
decoration "Aras"
Fixed panels satin finish low iron glass
Invisible sliding door system V-7300
with two sliding doors and two fixed panels
Glass handle satin finish M-009





**Sistema scorrevole EVOLUTION V-5303
con sistema "soft-close"
Ante mobili in vetro satinato decorato "RIGHE 3",
ante fisse in vetro verniciato nero un lato
effetto coprente
Maniglioni Round H500**

EVOLUTION V-5303 sliding system with "soft-close"
Sliding satinated door decorated "RIGHE 3",
fixed panel with satin glass
Pullhandle Round H500





Anta va e vieni tutto vetro, retro laccato color terra decorato "JUNGLE"
Stipite in alluminio anodizzato per passaggio a giorno
Cerniere automatiche V-508
Pomolo in cristallo trasparente

Terra painted glass door with sandblasted decoration "JUNGLE"
Alluminium jambs architraves, 180° hinges
Transparent glass knob

Box doccia composto da vetro fisso trasparente lato lungo, anta va e vieni con lato fisso a parete

Shower box consists of fixed transparent glass, automatic hinges door with fixed glass panel



Sistema scorrevole "V 5103" verniciato
Vetro satinato dipinto a mano mod. "Carnevale"
composto da due vetri fissi e due vetri scorrevoli contrapposti
Maniglioni inox verniciati colore marrone "Square 41"

Sliding system using tempered
satin glass "Carnevale" hand painted
Two fixed panels and two sliding panels on each side
Square 41 handles



**Doppia anta scorrevole a scomparsa, vetro satinato con decoro HaKa-Cha
Pomoli in cristallo satinato, stipite in alluminio anodizzato sezione quadrata**

Double pocket sliding doors with Haka-Cha decorated satin finish glass
Satin glass handle, aluminium jambs and architraves





Vetri decorati

Decori realizzabili su vetro trasparente o satinato sia su ante "tutto vetro" che intelaiate

Patterned glass

Satin etched glazed or frameless glass door, patterns on transparent or satin glass

Scelto il soggetto, artistico, fantastico o geometrico, viene riprodotto su lastra di vetro satinato tramite sabbiatura ottenendo il classico effetto luminescente. In alternativa si può lavorare su lastra float, andando a sabbiare tutta la superficie per ottenere il disegno prescelto in trasparente; in questo caso, a lavoro ultimato, la lastra decorata viene trattata con un prodotto idrorepellente, al fine di proteggerne la delicata smerigliatura.

Having chosen the desired theme (any theme can be reproduced; artistic, geometric or creative) it is reproduced on a satinated sheet of glass at varying depths to obtain the desired luminescent effect.

Another option is to sandblast the surface over a stencil creating a transparent design that is then protected with a water repellent finish.

k

Sabbiature ed applicazioni a freddo possono essere realizzate su lastre di cristallo trasparente satinato temprato o stratificato secondo norme U.E., di vari spessori da applicare a tradizionali telai o a forme tra le più svariate. Nuove proposte decorative e ad effetto. Richiestissime sono le soluzioni di arredo moderno sia in abitazioni private che in studi, ambienti pubblici ed uffici.

Modern interiors in both private and commercial environments require new and innovative designs. Karis designs can be manufactured on to transparent or satin, either tempered or safety glass in line with the latest European norms.

Ala



Alba



Alga



Anarchia



Aras



Arteficio





Astro



Bleu



Brio



Butterfly



Calici



Campanelle



Campestre



Contact



Corniqua



Corniri



Corsie

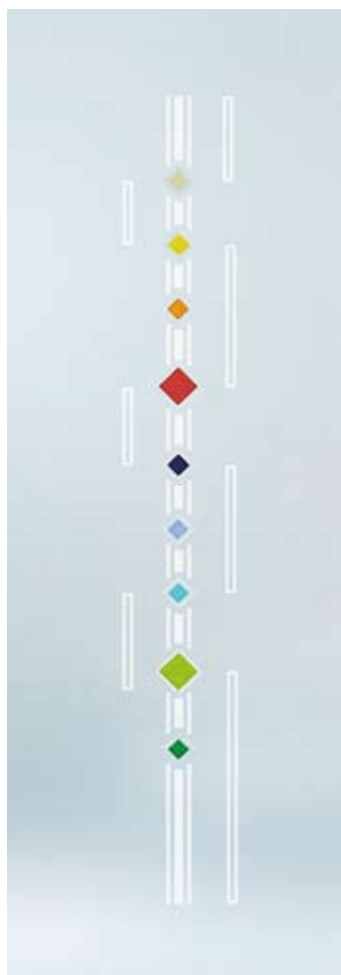

Crash



D.M.



Dea



Decò



Domus



Fibre



Fireworks

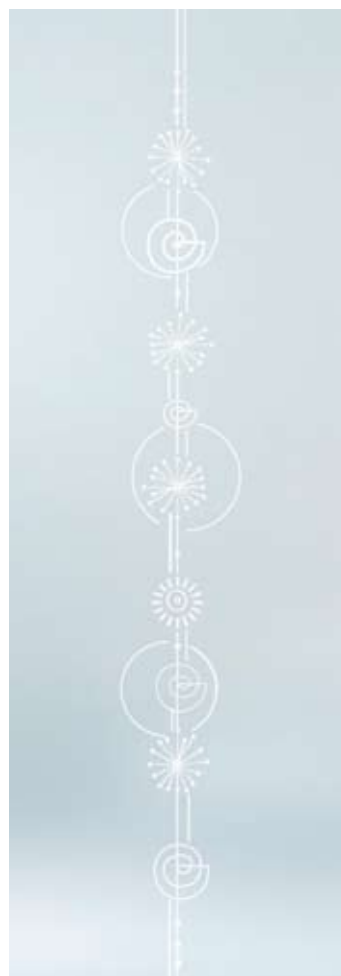



Florida



Gabbiani



Giza

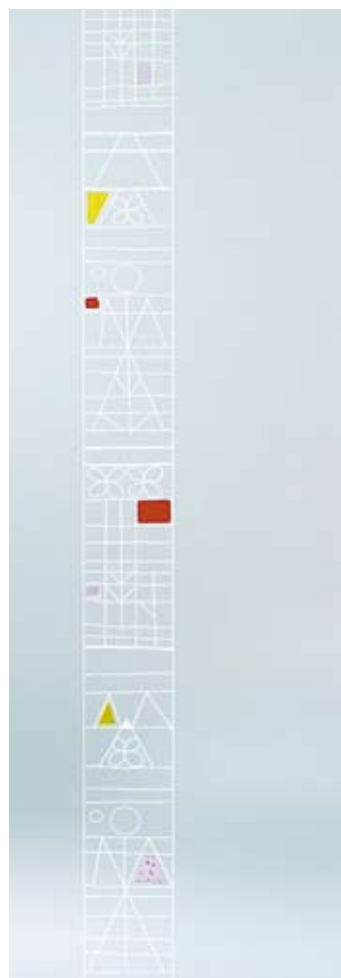

Grafismi



Haka



Cha





Greca

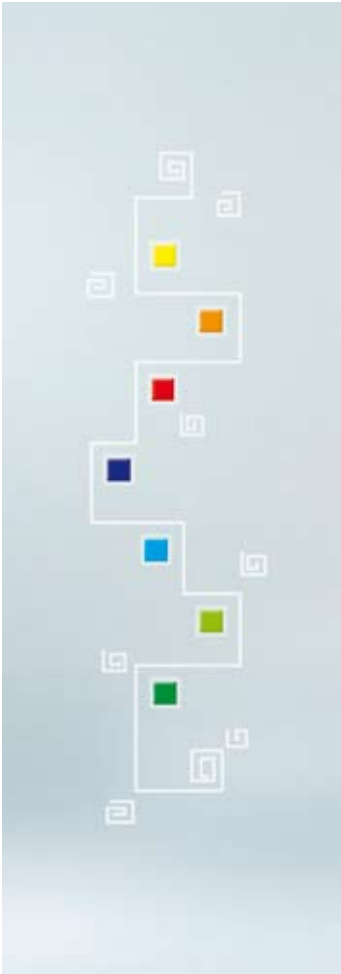

Horos

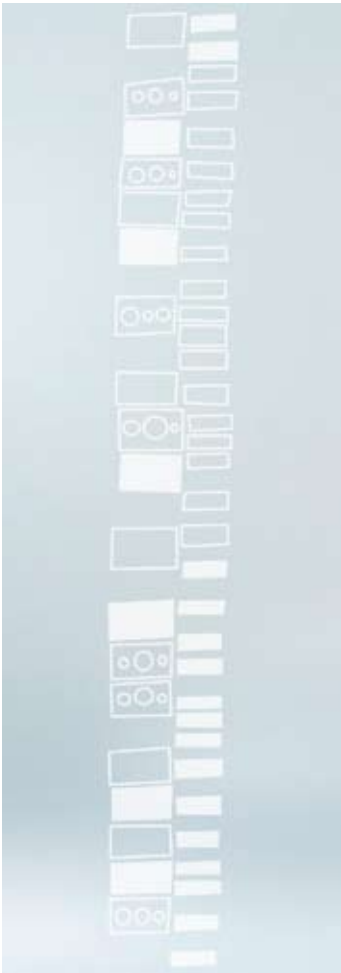

Immersione



Impronte

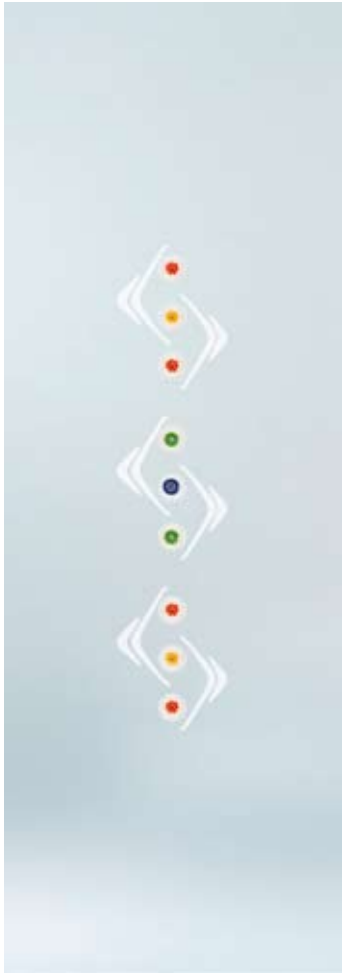

Indi

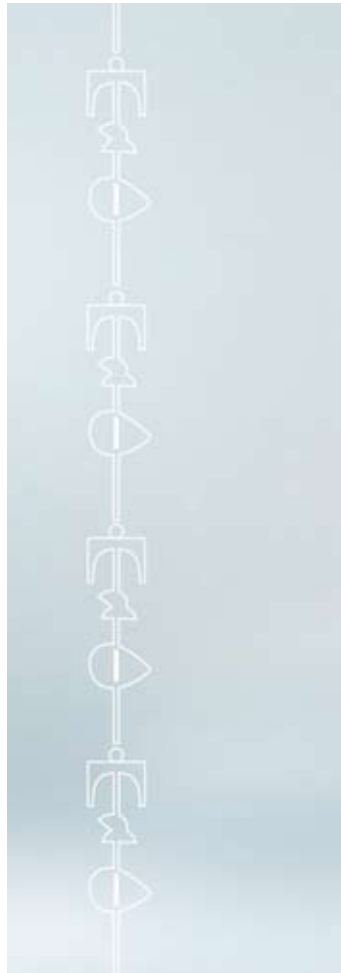

Intuizione Sx



Intuizione Dx



Jungle



Kimi



Maya



Millerighe



Naipo





Nebbia



Obliquo

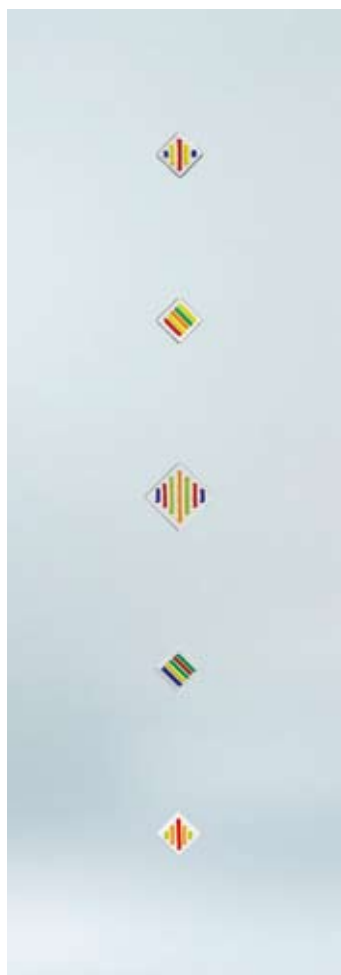

Paris



Psyco



Pupa



Quadrello

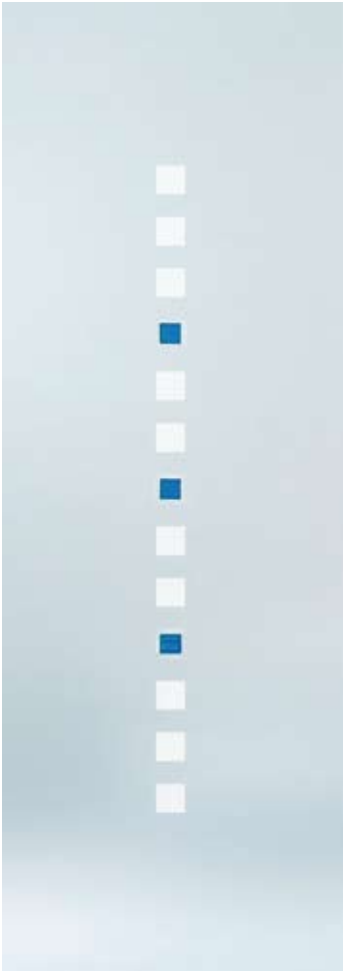

Riflessi



Righe 1



Righe 3



Rosapesco



Rouge



Sales





Segmenti



Speculare



Spezie

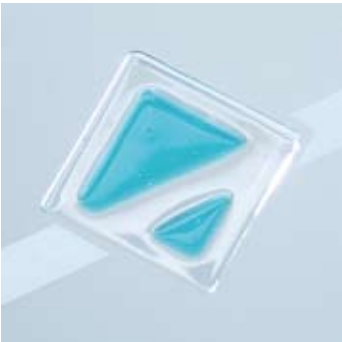

Spicchi



Stampa 1



Stampa 2



Stargate



Stones



Trama



Tramonto

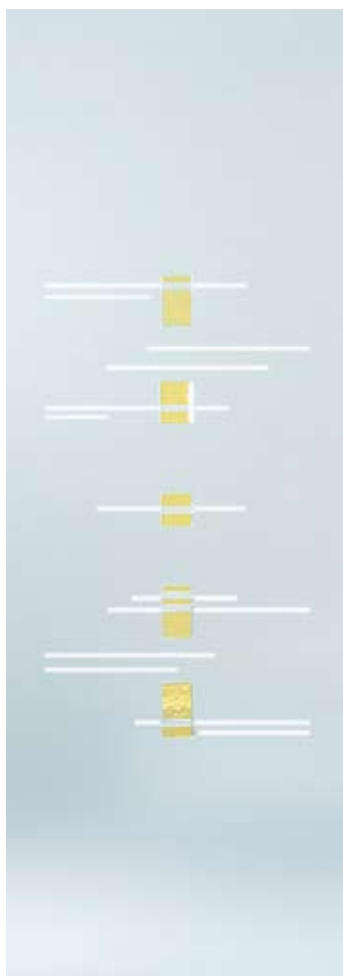

Victoria



Yo Yo

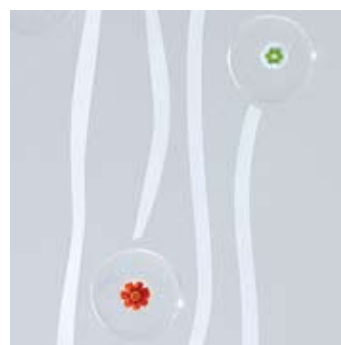





Vetro satinato, visibilità a 10 cm di distanza

10 cm (4 inches) from the glass

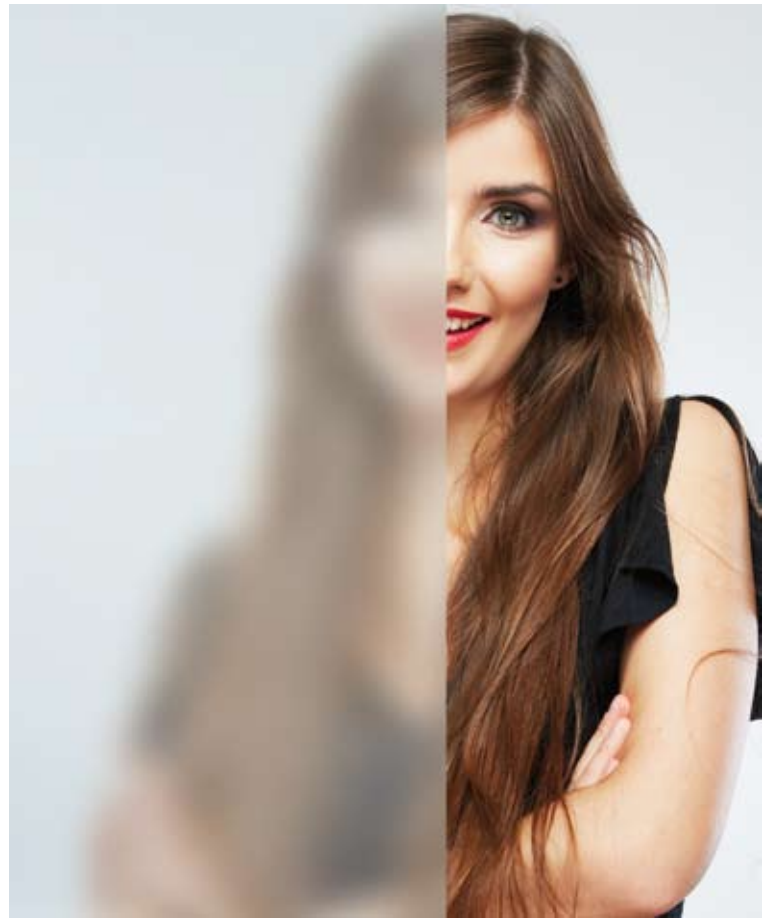

Vetro satinato, visibilità a 30 cm di distanza

30 cm (12 inches) from the glass



Vetro satinato, visibilità a 100 cm di distanza

100 cm (40 inches) from the glass



P8017
Bianco - White

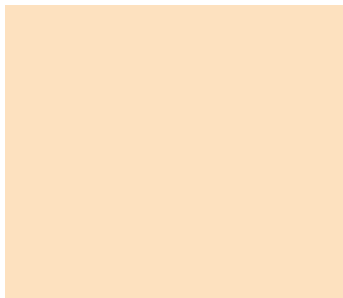

P8665
Beige - Beige



P8090
Arancio puro - Pure orange



P8033
Arancio segnale - Signal orange



P8005
Rosso - Red

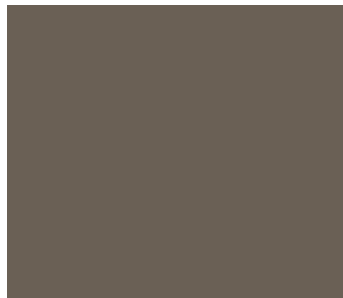

P8234
Terra - Terra

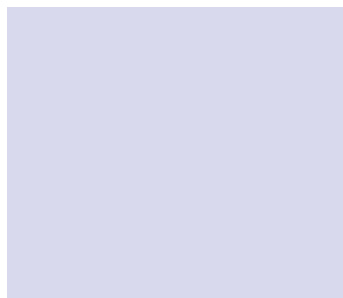

P8199
Lilla - Lilac

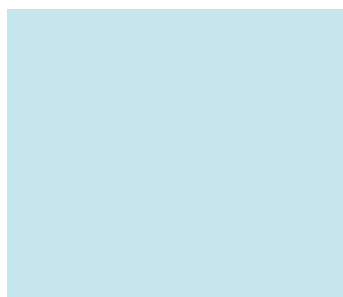

P8051
Azzurro - Light blue



P8088
Blu - Blue



P8125
Verde brillante - Bright green



P8034
Grigio - Grey

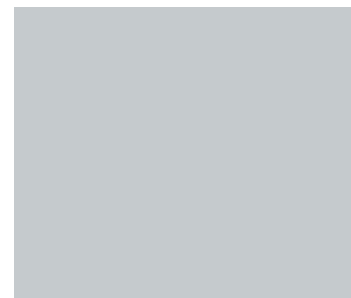

P8058
Argento metallizzato - Silver

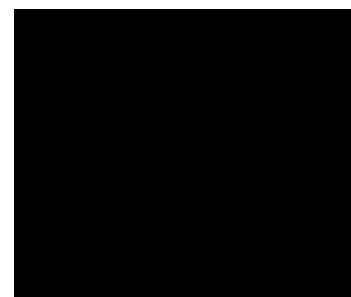

P8203
Nero - Black

Applicazioni a freddo

Murano glass coloured inserts

Per "applicazioni a freddo" si intendono i tozzetti in vetrofusione. E' possibile comporre un decoro personalizzato, sia su vetro trasparente che su vetro satinato. Scegliete tra i vari modelli, visibili nelle pagine successive, quelli di vostro interesse. Verranno applicati sul vetro scelto (trasparente o satinato) secondo la disposizione da noi indicata.

Murano Glass Coloured Inserts: choose from a wide range of designs on the following pages on either transparent or satin finish glass. Our artists can also reproduce your own individual designs if required, or develop a theme or idea for you.



TZ 0405



TZ 0408



TZ 0411



TZ 0414



TZ 0421



TZ 0424



TZ 0425



TZ 0428



TZ 0430



TZ 0434



TZ 0446



TZ 0449



TZ 0455



TZ 0458



TZ 0460



TZ 0463



TZ 0465



TZ 0468



TZ 0470



TZ 0473

La dimensione standard delle applicazioni a freddo è di mm 50x50 / Ø mm 50

Dimensions of inserts 50x50 mm / 50 mm dia

Vetrofusione a base ossido

Oxide based glass fusion

Tecnica antichissima usata già dai Fenici: le formelle sono ricavate da lastre di vetro tirato e colorate a disegno con ossidi metallici sapientemente mescolati per ottenere le varie sfumature cromatiche. Nella fusione, si sprigiona ossigeno che, rimanendo imprigionato nella lastra, produce il caratteristico e incontrollabile effetto "bollicina" che dona brillantezza, movimento e unicità all'oggetto.

This ancient technique was first used by the Phoenicians: tiles made from glass that has been carefully coloured, stretched and cut to obtain the desired chromatic shades. During the process, oxygen is released inside the glass creating small bubbles which gives this product its unique and distinctive finish.

Luna



Sole



Girasoli



Calle



Glicine



Primavera



Sentiero



Niagara



Sterlizia



Astri



Vetrofusione a base murano

Murano glass fusion

Peculiare lavorazione di vetrofusione in cui il disegno viene creato dall'accoppiamento della lastra base con particolari vetri precolorati prodotti da case vetraie muranesi. L'abilità realizzativa è data sia dallo studio del disegno a mosaico che dall'uso di vetri e cromie tecnicamente compatibili tra loro. L'effetto brillante dato dai colori intensi e dagli inserti a rilievo, si ottiene grazie alle alte temperature di fusione.

An unusual process of glass fusion using a sheet of glass and mosaics from the artists of Murano. This beautiful result is obtained by carefully selecting the coloured mosaics with particular characteristics which withstand the high temperature fusion leaving the brilliant, intense colours intact.

Acquario



Rampicanti



Arlecchino



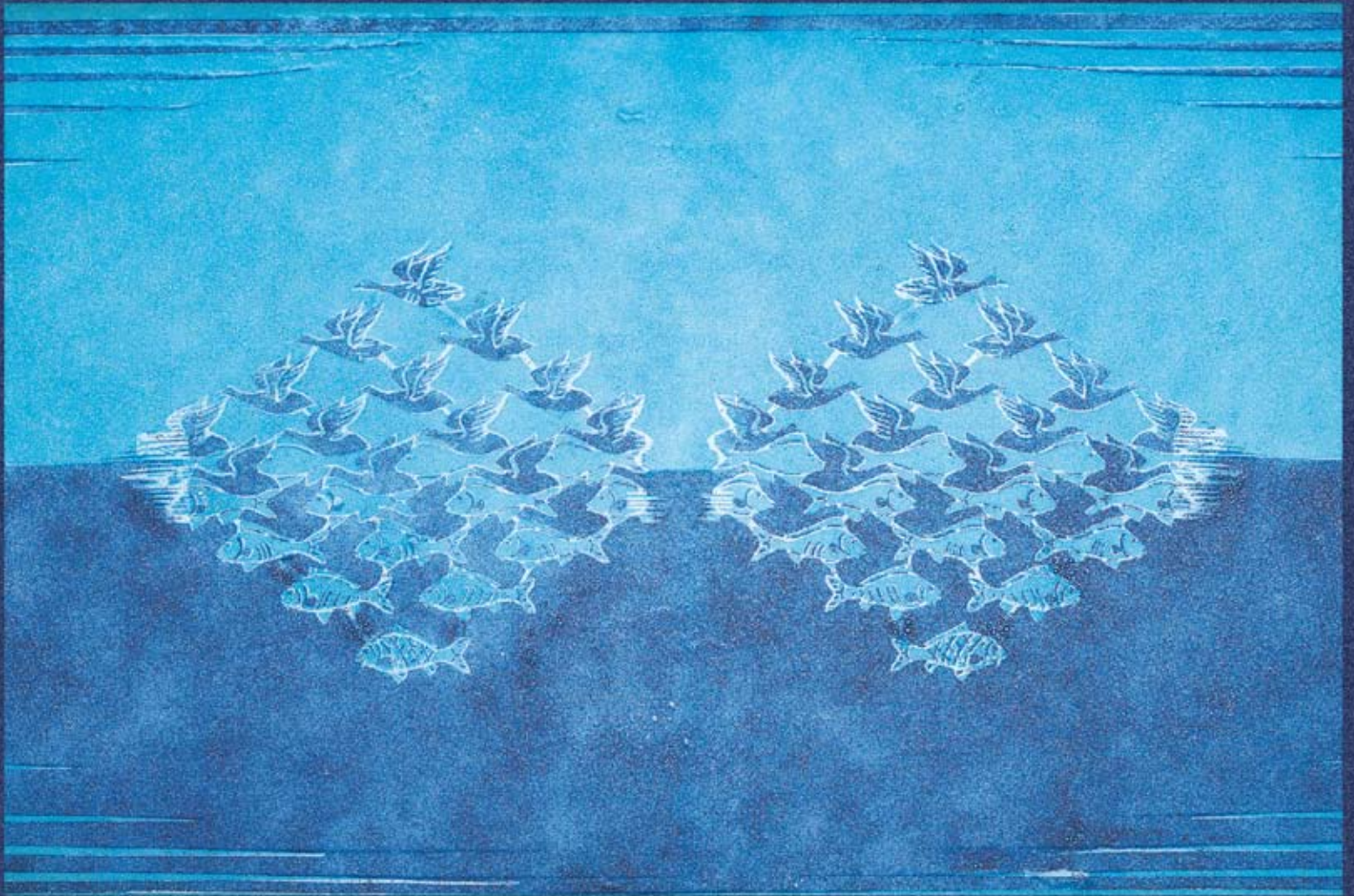

Metamorfosi

Campionario base ossido

Examples of oxidized glass inserts



Campionario base murano

Examples of murano glass inserts



Porta a battente tuttovetro con decoro dipinto a mano "NINFE" dedicato a G.Klimt
Cerniere V-202 , serratura V-200, maniglie mod "DALI" V-231

Hinged door decorated "NINFE" dedicated to Klimt with hinges V-202 ,
lock V-200, doorhandle "DALI" V-231





Vetri dipinti a mano

Hand painted glass

Vengono qui riprodotti soggetti dipinti a mano dai nostri artisti, alcuni dei quali sono dedicati ai grandi maestri dell'arte pittorica del passato.

These hand painted examples show the capability of our own in-house artists, (with some influence from the old Masters).

Afro



Carnevale



City



Chioma



Dedicato a Klimt



Fantasie



Garden



Geometrie



Ninfe



Volatile

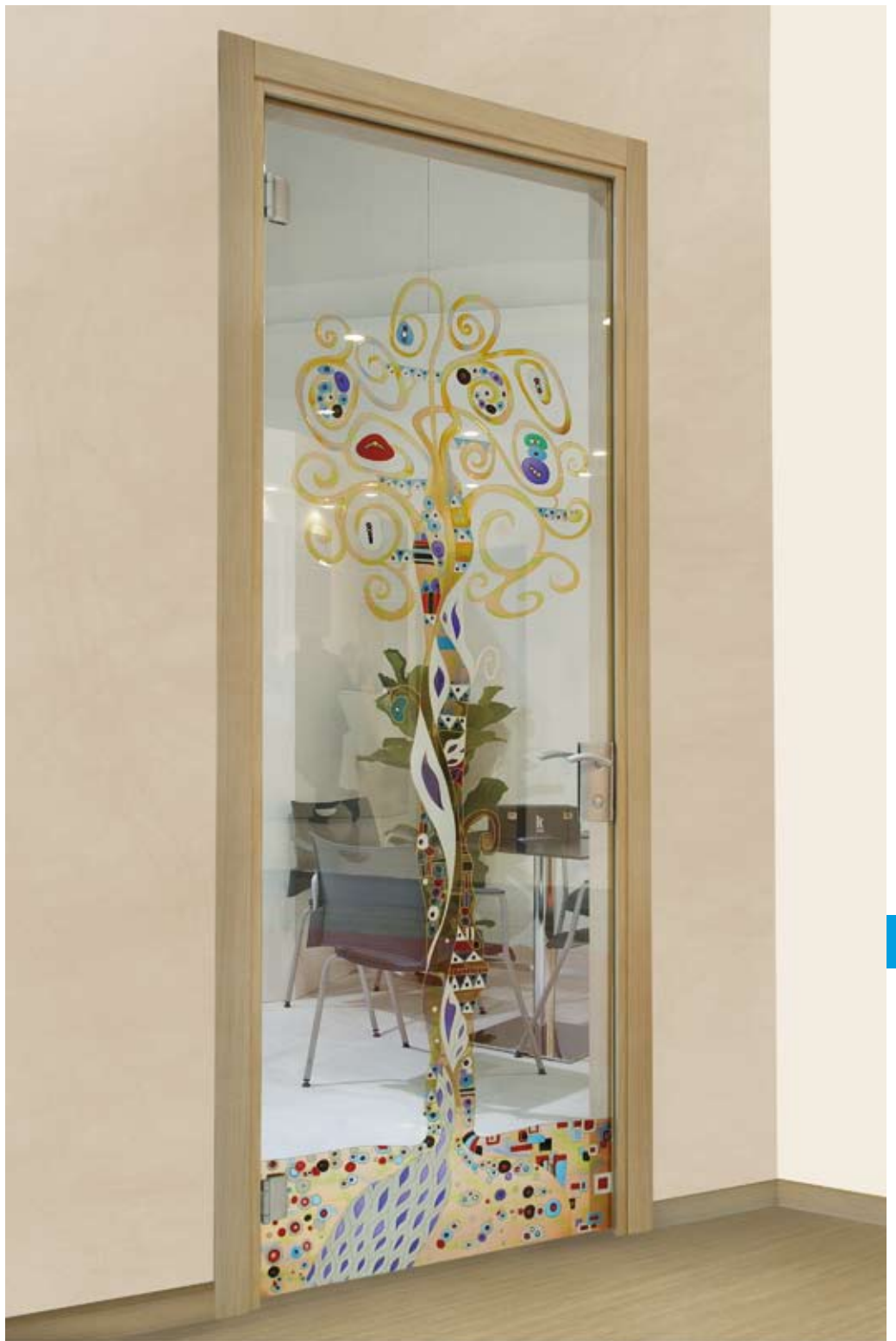

Porta a battente tuttovetro con decoro dipinto a mano "CHIOMA" su vetro trasparente
Cerniere V-409, serratura Magnetika V-350 tutto finitura cromo satinato

Hinged glass door decorated "CHIOMA" on transparent glass
Hinges V-409, magnetic lock V-350 all satin chrome finish



Vetro fusione base ossido decorata "GLICINE" intelaiata in legno

Glass work based oxide decorated "GLICINE"

Sistema scorrevole a scomparsa
Anta vetro satinato decorato "ROSAPESCO"
con pomolo in cristallo satinato
Stipite in legno laccato RAL 9010

Sliding pocket system
Satin glass door decorated "ROSAPESCO"
with satin glass knobs
White lacquered wooden jambs



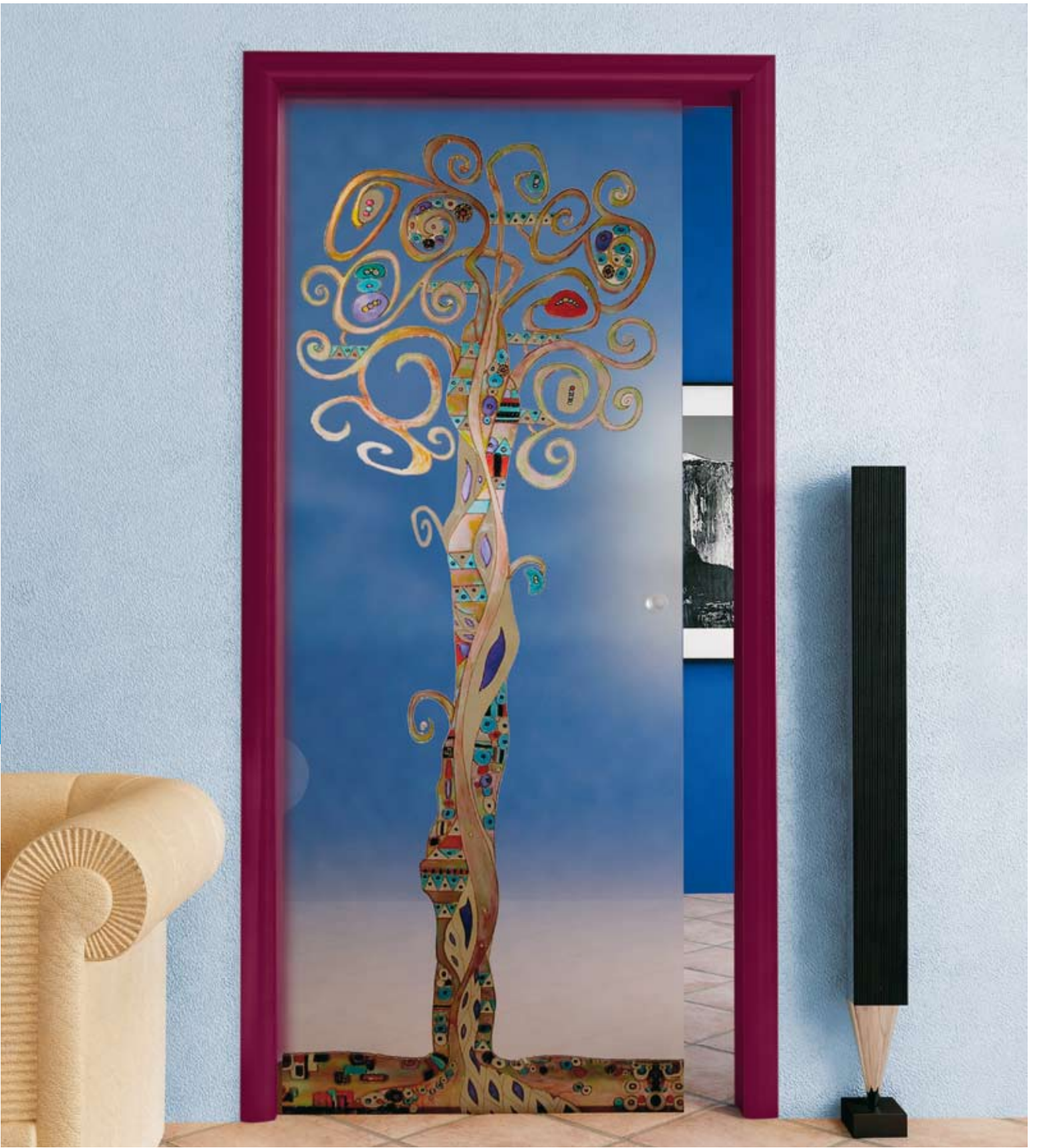

Anta scorrevole vetro satinato con decoro dipinto a mano "CHIOMA"

Pocket sliding satin glass door with hand painted decoration "CHIOMA"



**Anta scorrevole a scomparsa intelaiata in legno
con vetro satinato stratificato decorato "YO-YO"**

Wooden framed sliding pocket door with laminated
satin glass decorated "YO-YO"



Porte scorrevoli intelaiate con profilo
PO-290 con binario a scomparsa
nel cartongesso

Aluminium frame sliding door PO-290
with ceiling rail installation

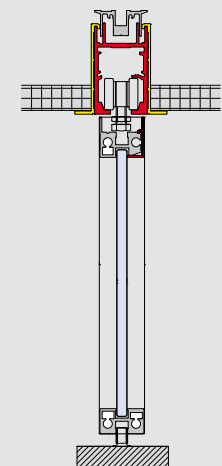
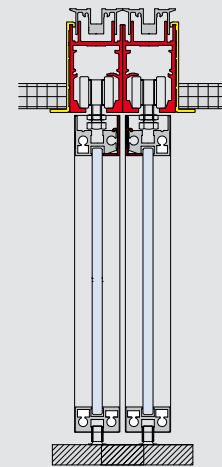





**Porte scorrevoli intelaiate su binario
a vista V-1610**

Aluminium frame sliding door PO-290
with visible rail V-1610

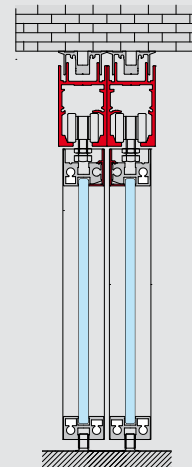



**Sistema scorrevole INDIPENDENT V-8000 con borchie a vista
Anta vetro 10 mm temprato, retro laccato colore grigio, completa di maniglione Round H300**

INDIPENDENT V-8000 sliding system with visible point fitting
Grey coloured 10mm glass door with Round H300 pullhandle

Sistema scorrevole INDIPENDENT V-8050 con tappi inglobati
Vetro float 5+5mm temprato stratificato con plastico colore P8005, Nicchia V-524

INDIPENDENT V-8050 sliding system with not visible point fitted
Transparent 5+5mm tempered glass laminated with P8005 pvb, Sliding door handle V-524





**Sistema scorrevole INDIPENDENT V-8100 con veletta
Ante vetro fume' con lavorazione effetto satinato
Nicchia V-524**

INDIPIENDENT V-8100 sliding system with cover profile
Fume glass doors with satin effect
Sliding door handle V-524

**"V-1000" Sistema scorrevole Easy
Nicchia V-524**

"V-1000" Easy sliding door system
Sliding door handle V-524



**Porta scorrevole a scomparsa su
controtelaio senza stipite
Anta vetro float 5+5 temprato stratificato
con plastico nero, inserto scultura su
vetro realizzata per Karis srl dallo scultore
italiano Luigi Camozzo
Nicchia V-406**

Frameless sliding pocket system
Tempered 5+5 glass door laminated with black
pvb, decorated glass insert realized by Italian
sculptor Luigi Camozzo
Sliding handle V-406



**Porta a battente tuttovetro trasparente su profilo a stipite P-030
Cerniere V-509, serratura V-300, maniglie modello MILANO**

Transparent hinged glass door on aluminium frame P-030
Hinges V-509, lock V-300, handle MILANO

Anta battente in vetro satinato intelaiata con profilo PO-100

Satin glass with PO-100 profile





Art. P 040
Profilo stipite in battuta.

Hinged door with surface mounted frame.

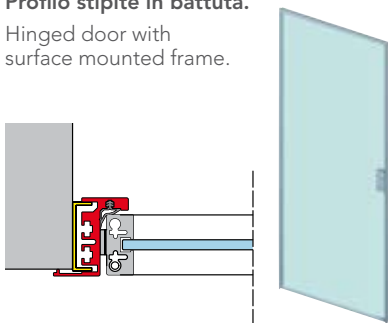

Art. P 030
Profilo stipite in luce in alluminio anodizzato.

Frameless glass door with anodised aluminium frame.

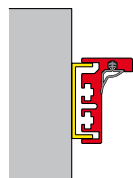

Art. P0 100
Anta vetro con telaio in alluminio.

Glass door with anodised aluminium frame.

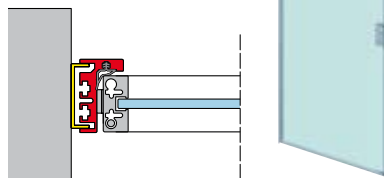

Anta tutto vetro.
 Glass door.

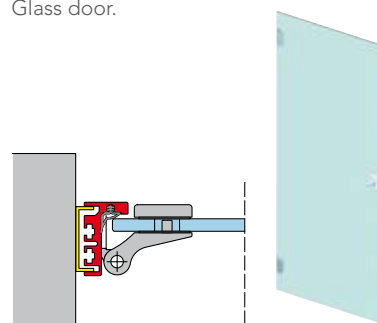





Porta scorrevole curva a scomparsa
Vetro satinato extrachiaro
Maniglione "Attack H-410", finitura
alluminio anodizzato

Curved glass sliding pocket door
made ok low iron glass
Pull handow Attack H-410
aluminium finish

Sistema "Easy doppio V 1200" per due ante scorrevoli
Nicchia "V-522"

Sliding system "Easy doppio V 1200"
"V-522" handle





Anta a libro, vetro trasparente
Cerniere vetro-vetro "V-513", cerniere vetro-muro "V-509"
Calamita di tenuta

Folding transparent glass door
Hinges for glass/glass V-513 , hinges V-509, holding magnet

Particolare del sistema di scorrimento

Close-up of sliding mechanism



Anta scorrevole in vetro laccato nero
effetto coprente
Pomoli in cristallo trasparente
Sistema scorrevole Minimal Quadro "V-6300"

Sliding black painted glass door
Transparent glass knobs
Minimal Quadro sliding door system V-6300



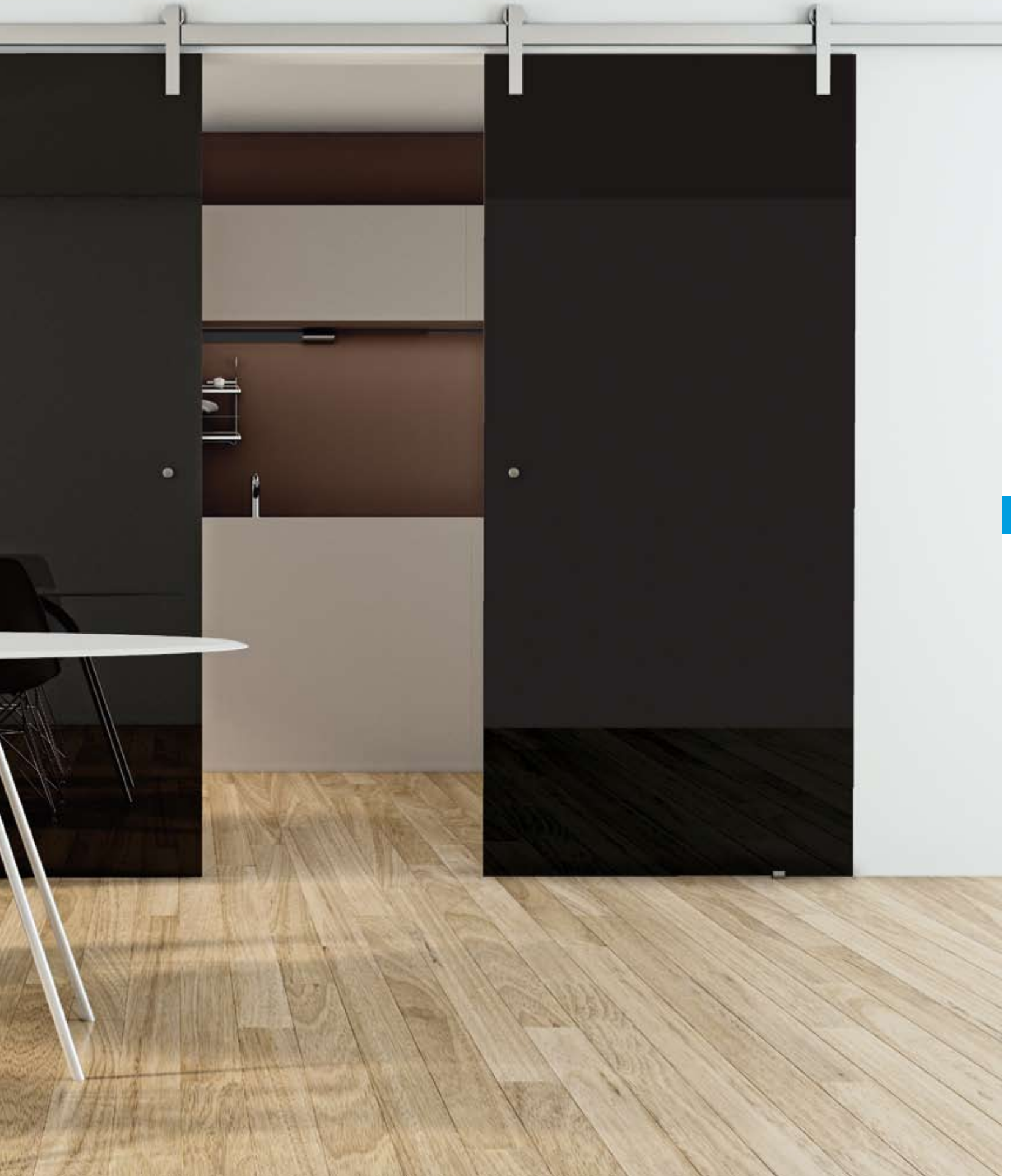

**Sistema scorrevole telescopico "V-4000"
Nicchia "V-506"**

Telescopic sliding system V-4000
with satin glass and V-506 handle



**Particolare
scorrevole telescopico**

Telescopic sliding door system
detail



**Sistema scorrevole a soffietto "L-2500",
impacchettamento centrale senza guida a pavimento
Nicchia "V-522"**

Folding sliding glass door L-2500, with no floor rails
V-522 handle

Sistema scorrevole per box doccia
COMPACT BX-1000
(disponibile in varie combinazioni)
Vetro trasparente temprato
Pomoli B-168 tutto cromo lucido

Shower box COMPACT BX-1000
(available in many combinations)
Transparent tempered glass
Knobs B-168 all aluminium polished chrome





Vetro fisso temprato stratificato con plastico colorato
Profilo a scatto per vetri fissi P-050

Laminated tempered glass panel with coloured fill layer
Profiles P-050 for fixed panel





**Parapetto in vetro trasparente temprato stratificato,
fissaggio a cosciale tramite distanziali modulabili DP-044**

Glass banister with tempered laminated transparent glass
fixed by modular point fittings DP-044





Parapetto in vetro con profilo balaustra
 "Jolly Pack" B-2000
 Vetro 10+10

Glass banister with Jolly Pack profile B-2000
 Tranparent glass 10+10



Pensilina in vetro trasparente
 modello "PRESA"
 Vetro 6+6

Transparent glass canopy "PRESA"
 Glass 6+6



Accessori
Accessories



M-001



M-002



M-003



M-004



M-005



M-006



M-007



M-010



M-011



M-013



M-014

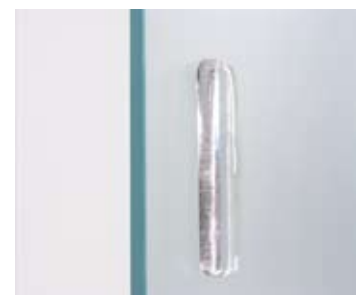

M-008



M-009



M-012

Maniglioni

Pull handles

Nicchie

Handles



Round 02

Maniglione - Pull handles
Ø 20 A 200 L 300/500/700 mm



V-406

Nicchia a raso muro
Sliding handle with pull-lever



V-506

Nicchia scorrevole grande
Sliding door-handle



Square 40

Maniglione - Pull handles
19x19 A 200 L 217 mm



V-522

Nicchia quadra per scorrevole
Sliding door-handle square



V-511

Nicchia scorrevole grande
Sliding door-handle



Square 41

Maniglione - Pull handles
19x19 A 200 L 300/650 mm



Attack POR-0408V

Maniglione - Pull handles
L 260/410/560 mm



V-524

Nicchia tonda Ø 60
Sliding door-handle Ø 60



V-504

Serratura minima con gancio
Lock with hook minima

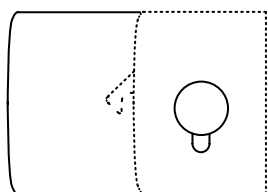

V-504 2FLG

Controserratura montaggio a muro
Striker for wall installation



V-529

Controserratura montaggio a muro
Striker for wall installation

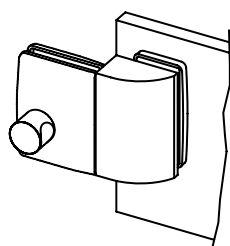

V-530

Controserratura montaggio su vetro
Striker for glass installation



V-017

Morsetto tondo
Clamp



P-050

Profili a scatto per fissi
Profiles for fixed panels

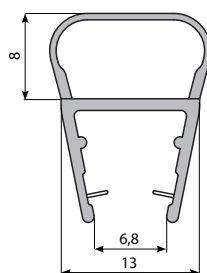

V-041

Guarnizione a palloncino
Gasket



V-003-8

Catenacciolo per porta doppia
Locking bolt



V-012

Guida a pavimento regolabile
Adjustable floor guide



V-509

Cerniera Slim con aletta fissaggio
Slim side hinge with fixing plate



V-107

Cerniera Slim pavimento/soffitto
Top bottom hinge with height



Calamita per anta a libro

Magnet for folding system



V-709

Cerniera Libra con aletta fissaggio
Side hinge Libra with fixing plate



V-409

Cerniera verticale Stilo con aletta
Side hinge Stilo with fixing plate

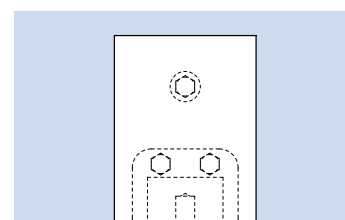

MQ-1

Cerniera inferiore / superiore
Top / bottom patch



V-508

Cerniera automatica con apertura 180°
Automatic hinge with opening 180°



V-513

Cerniera Slim verticale vetro / vetro
Slim hinge for glass / glass

**V-200**

Serratura Economy - Economy lock

**V-500**

Serratura Minima - Minima lock

**V-600**

Serratura Round - Round lock

**V-700**

Serratura Square - Square lock

**V-350**

Serratura Magnetika - Magnetika lock

**V-750**

Serratura Verticale - Vertical lock

**HCL V-800 / V-800 2FLG**

Serratura Compact - High Compacted lock





Particolari

Details





www.karis-srl.com

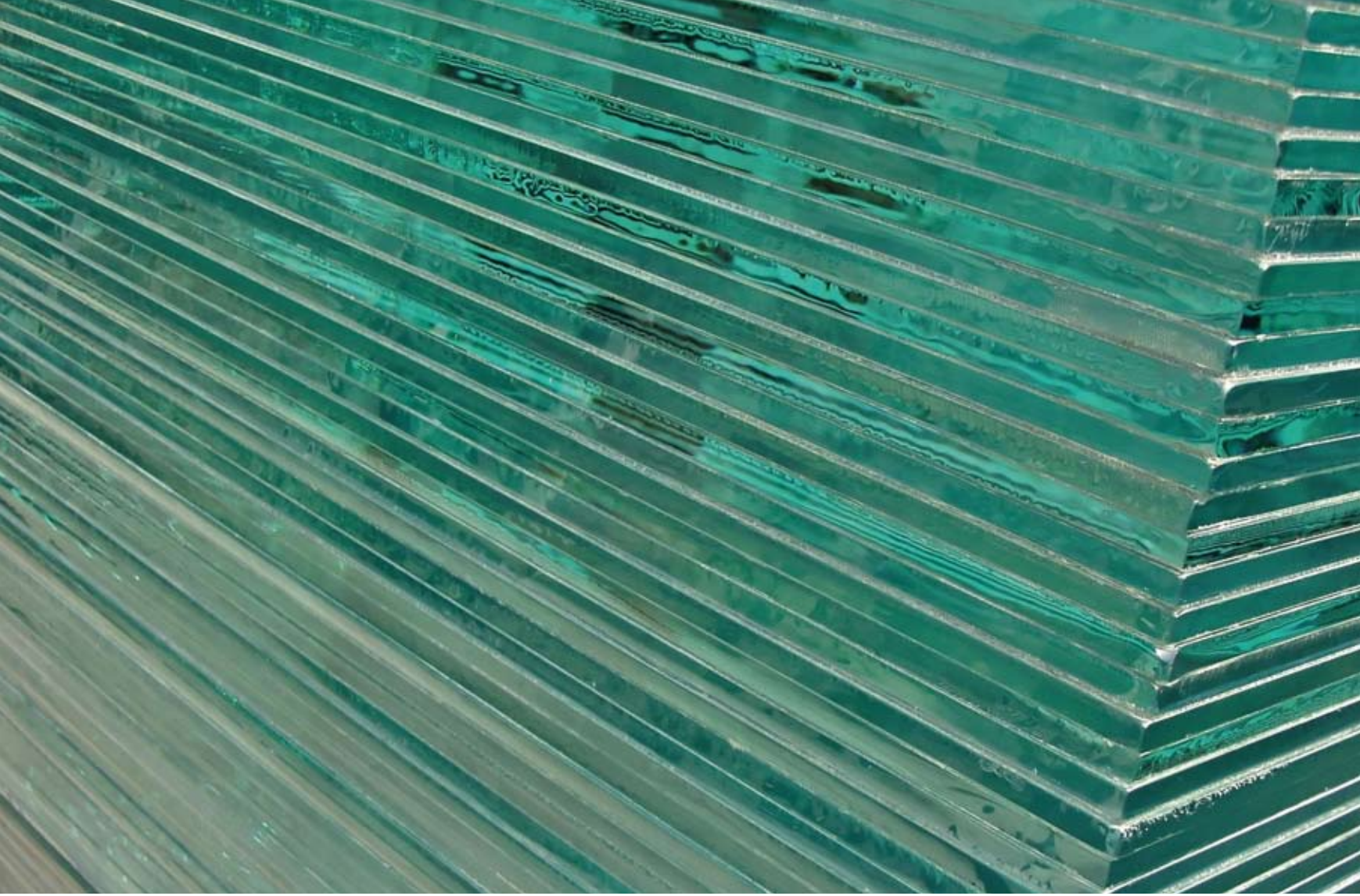

Karis Srl
Via Cal De Prade, 87/89
31029 Vittorio Veneto (Tv) - Italia
Tel. +39 0438 555468
Fax +39 0438 946413
www.karis-srl.com

Amministrazione
Administration
amministrazione@karis-srl.com

Area tecnica
Technical area
info@karis-srl.com

Area commerciale
Commercial area
daros@karis-srl.com
guido@karis-srl.com

Le creazioni Karis all'estero
Karis creations available worldwide

Glass Door Designs
Richmond House 2, Occupation Lane
Gonerby Moor, Grantham NG32 2BP
United kingdom
Tel. +44 (0)1476 542807
Fax +44 (0)1476 560951
sales@glassdoordesigns.co.uk
www.glassdoordesigns.co.uk

Eclisse uk
Richmond House 2, Occupation Lane
Gonerby Moor, Grantham NG32 2BP
United kingdom
Tel. +44 (0)1476 565497 or +44 (0)845 4811977
Fax +44 (0)1476 560951
info@eclisse.co.uk
www.eclisse.co.uk

Marsica special doors & frames b.V.
De Scheysloot 40,
2201 GN Noordwijk
Netherland
Tel. +31 71 4050050
Fax +31 71 4050051
info@marsica.eu
www.marsica.eu



www.karis-srl.com



www.facebook.com/KARIS.SRL



www.twitter.com/KARISSRL

